



自動回歸緩衝關門器

KSW1002B 鈦金黑
KSW1002G 鈦金灰
KSW1002S 璀璨銀

耐風壓效果高，可用於密閉空間

不用安裝“插銷”，不用拆放“壓力螺絲”

拆卸安裝時，不會夾手



不分左右邊，可重複使用

最大開啟角度180°

135°~85° 可隨意停

90°沒有定位“喀嚓”聲

重量級-最大承重300kg (緩衝承重100kg)

隱藏暗門/門鎖式 雙向功能

型號 G2



開關門測試
認證通過 SGS

1,400,000 次



康士威科技建材股份有限公司
KANSWAY TECHNOLOGY BUILDING MATERIAL CO.,LTD.



康士威集團有限公司
KANSWAY GROUP LIMITED

TEL:02-77515372
MADE IN MALAYSIA



2022.02 版

自動回歸 緩衝 關門器



KANWAY®

1,400,000 次

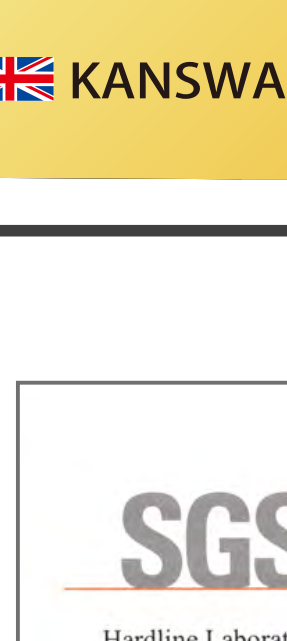

(不分左右邊)

KANSWAY GROUP LIMITED

開關門測試
認證通過 SGS

HL90432A/2021

安裝說明書

型號:KSW1002(雙型款)

100kg↓



SGS國際認證報告

P1

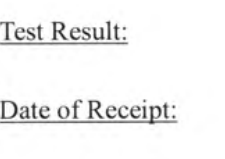

TEST REPORT

Hardline Laboratory

Report No.: HL90432A/2021

英國 康士威科技建材集團有限公司
KANSWAY GROUP LTD

Page: 1 of 2

20-22, Wenlock Road, London N1 7GU

Date: FEB. 16, 2022

The following merchandise was submitted and identified by the applicant as:

Product Description: KANSWAY Automatic regression buffer door closer hinge

Style/Item No.: KSW1002 series KANSWAY自動回歸緩衝關門器

Manufacturer/Vendor: KANSWAY GROUP LTD

Country of Origin: Malaysia (馬來西亞)

We have tested the submitted sample(s) as requested and the following results were obtained:

- Test Requested: Durability test
- Test Method:
1. Secure the two hinges on the door then fixed on the working frame.
 2. Open the door by using a gas cylinder to an angle of (70 ± 5) degrees and close the door to the original position as one cycle.
 3. Totally executing 1,400,000 cycles.
 4. Tested Door Weight: 40 kg; Size: 85 cm x 200 cm
 5. Frequency: (8 ± 1) cycles/minute
 6. After testing, check the sample for visible damage and record any findings.

Test Result: ---See following sheet(s)---

Date of Receipt: Sep. 27, 2021

Testing Period: Sep. 27, 2021 ~ Jan. 21, 2022

自動回歸緩衝關門器開合測試

Signed for and on behalf of
SGS Taiwan Ltd.

Sturm Su
Manager

Address of Lab: No.127, Wu Kung Road, (New Taipei Industrial Park)
Wuku District, New Taipei City, Taiwan

This document is issued by the Company subject to its General Conditions of Service printed overleaf, available on request or accessible at <http://www.sgs.com.tw/Terms-and-Conditions> and, for electronic format documents, subject to Terms and Conditions for Electronic Documents at <http://www.sgs.com.tw/Electronic-Documents>. Attention is drawn to the limitation of liability, indemnification and jurisdiction issues defined therein. Any holder of this document is advised that information contained hereon reflects the Company's findings at the time of its issuance only and within the limits of Client's instructions, if any. The Company's sole responsibility is to its Client and this document does not constitute a warranty or a transaction from any party. Any dispute or litigation shall be resolved in accordance with the arbitration agreement, if any, contained in the contract. Any unauthorized alteration, forgery or falsification of the content or appearance of this document is unlawful and offenders may be prosecuted to the fullest extent of the law. Unless otherwise stated the results shown in this test report refer only to the sample(s) tested.

SGS Taiwan Ltd. 127, Wu Kung Road, New Taipei Industrial Park, New Taipei City, Taiwan 新北市新北產業園區五工路127號
台灣檢驗科技股份有限公司 (886-2) 2289-3279 (886-2) 2289-2920 www.sgs.com.tw
Member of SGS Group

台灣SGS測試

康士威集團有限公司
KANSWAY GROUP LIMITED

SGS國際認證報告

P2



TEST REPORT

Hardline Laboratory

Report No.: HL90432A/2021

Page: 2 of 2

Test Result:	Sample	Cycles	Result
	KANSWAY Automatic regression buffer door closer hinge	1,400,000	No visible damage or loss of function was found after testing.

Note: The content of this report is invalid if it is not presented as the entire report.

--- Picture(s) ---

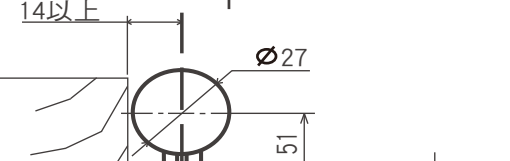

Photo A: Appearance of the sample(s)

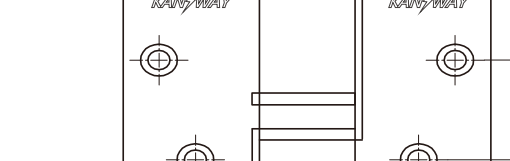

Photo B: Appearance of the sample (close view)

--- End of Report ---

測試結果：140萬次開合測試，無損壞狀況

This document is issued by the Company subject to its General Conditions of Service printed overleaf, available on request or accessible at <http://www.sgs.com.tw/Terms-and-Conditions> and, for electronic format documents, subject to Terms and Conditions for Electronic Documents at <http://www.sgs.com.tw/Electronic-Documents>. Attention is drawn to the limitation of liability, indemnification and jurisdiction issues defined therein. Any holder of this document is advised that information contained hereon reflects the Company's findings at the time of its issuance only and within the limits of Client's instructions, if any. The Company's sole responsibility is to its Client and this document does not constitute a warranty or a transaction from any party. Any dispute or litigation shall be resolved in accordance with the arbitration agreement, if any, contained in the contract. Any unauthorized alteration, forgery or falsification of the content or appearance of this document is unlawful and offenders may be prosecuted to the fullest extent of the law. Unless otherwise stated the results shown in this test report refer only to the sample(s) tested.

SGS Taiwan Ltd. 127, Wu Kung Road, New Taipei Industrial Park, New Taipei City, Taiwan 新北市新北產業園區五工路127號
台灣檢驗科技股份有限公司 (886-2) 2289-3279 (886-2) 2289-2920 www.sgs.com.tw
Member of SGS Group

台灣SGS測試

康士威集團有限公司
KANSWAY GROUP LIMITED

請依照門重及尺寸正確使用鉸鏈的數量

項次	門重	門寬度限制	門高度	鉸鏈數量
①	35-100kg	≤850mm	≤2200mm	兩個緩衝
②	35-100kg	≤850mm	2200-2500mm	兩個緩衝+一個無緩衝
③	100-120kg	850-950mm	≤2200mm	三個緩衝

**不
超
載
保
用**

※為確保產品品質及功能順暢，嚴禁搭配它牌商品一起使用。

鉸鏈安裝配置(請參照上表的項次 ① ② ③)

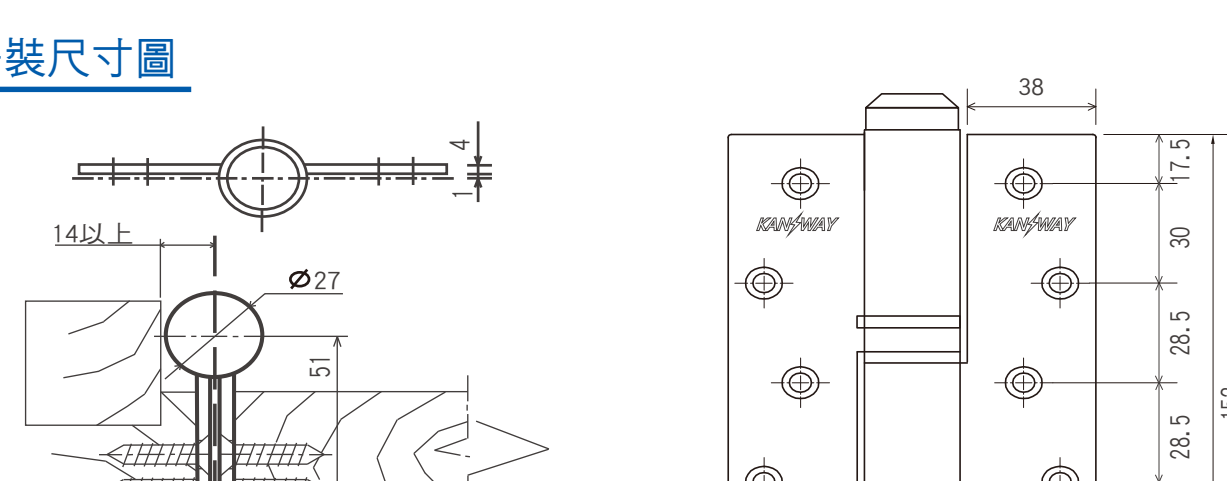

※請確實依照上圖所標示正確安裝鉸鏈及位置。

安裝尺寸圖



(單位: mm)

康士威集團有限公司
KANSWAY GROUP LIMITED

<安裝+調整只要3個步驟>

安裝步驟



打開包裝檢查產品及零配件是否齊全。
關門器*2、六角板手*1
ST螺絲*21、磁吸帽蓋*4
電動板手*1、說明書*1



將關門器安裝到門與門框上(無壓力狀態)
注意：
產品要箭頭朝上安裝



調整第二段30°~0° 關門速度
向左轉，速度快
向右轉，速度慢
(每個關門器都要調整)

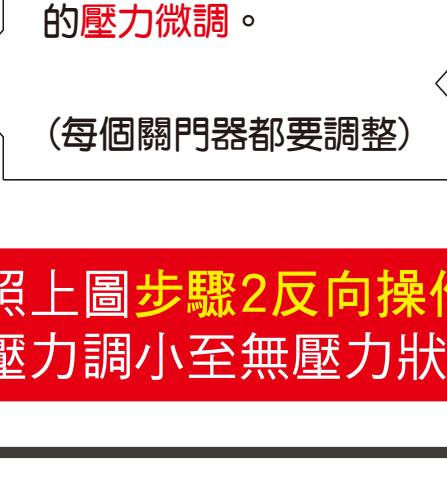

取六角板手，依實際門的重量做關門力道的壓力微調。
(每個關門器都要調整)

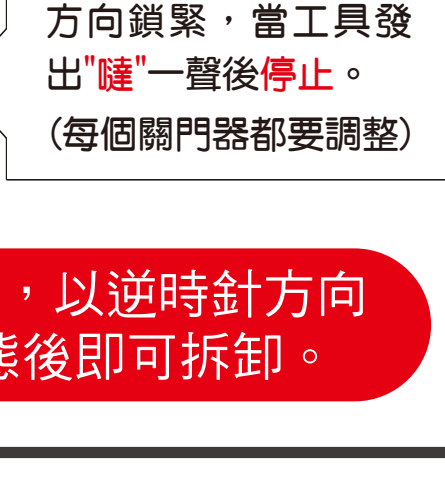

用黑色長條接頭，裝到工具上，依“順時鐘”方向鎖緊，當工具發出“嗒”一聲後停止。
(每個關門器都要調整)

拆卸方式 | 依照上圖步驟2反向操作，以逆時針方向把壓力調小至無壓力狀態後即可拆卸。

康士威集團有限公司
KANSWAY GROUP LIMITED

注意事項



請勿使用鐵槌敲擊



請勿開超過180度以上



門自動關上時請勿用力推

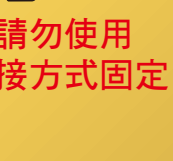

請勿使用焊接方式固定



www.kansway.com



kansway.tw

2021.12版